

**caratteristiche tecniche**  
**technical specifications**

L'apparecchio è dotato di speciali viti anti-effrazione apribili solo con una apposita chiave.  
The fixture is equipped with special tamper-proof screws that can be opened only by means of a special key.

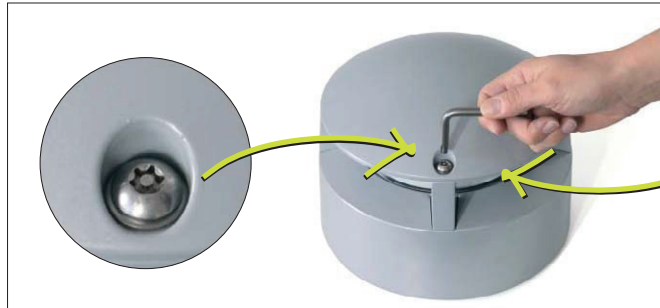

antivandalismo



Costruzione con materiali interamente riciclabili  
All the construction materials are fully recyclable

viteria in acciaio inox  
stainless steel hardware  
lega primaria di alluminio in pressofusione  
copper-free die-cast aluminium alloy



schermo e base in tecnopolimeri compositi  
base and screen in composite technopolymer

perfetta tenuta stagna  
IP67 schermo e base in tecnopolimeri compositi.  
perfect water-tightness  
IP67 can operate if occasionally submerged.



può funzionare momentaneamente sommerso  
can operated if occasionally submerged

semplicità di installazione  
easy to installation

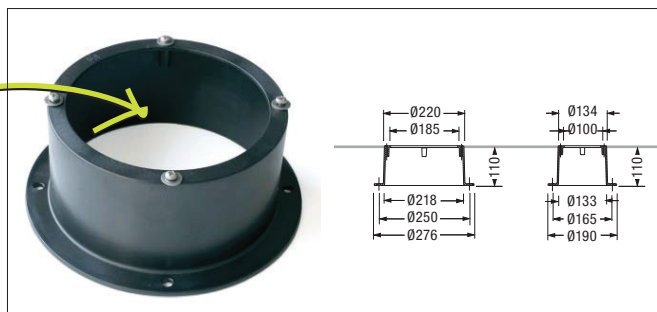

Con l'uso dell'accessorio D31/P, pozzetto da incasso nel terreno, le operazioni di installazione e allacciamento elettrico vengono notevolmente facilitate.

With the use of the D31/P accessories, ground recessed pit, installation and electrical connection is easily carried out.

pre-cablaggio  
Gli apparecchi zack sono dotati di cavo in uscita che consente un rapido allacciamento elettrico.

pre-wiring  
The zack fixtures are equipped with pre-wired cable for a fast electrical connection.



Con il semplice inserimento di settori oscuranti è possibile parzializzare l'emissione luminosa da 360° a singoli settori con ampiezza 90°.

With the use of darkening shields it is possible to limit the luminous emission from 360° to 90° single units.

massimo 2 per apparecchio  
max. two pieces per fixture



pali bassi/bollard  
low pole/bollard

**colori standard**

alluminio RAL 9006  
nero RAL 9005

**codice**

-AL\*  
-N\*

\* da aggiungere al codice prodotto

**caratteristiche apparecchio:**

- base di fissaggio in tecnopolimero composito ad alta resistenza
- corpo in alluminio pressofuso, resistente alla corrosione
- verniciatura a polveri poliesteri, previo pluritrattamenti contro la corrosione (supera il test di 1500 ore in nebbia salina)
- viteria inox AISI 304, antieffrazione apribile solo con apposita chiave
- guarnizioni in gomma ai siliconi
- lente (**zack**) schermo (**zack/F42 - zack/MLW**) in policarbonato infrangibile anti UV
- ausiliari elettrici incorporati 230V-50Hz
- completo di spezzone di cavo H07RN-F già collegato e collaudato a tenuta
- isolamento in Classe II (a richiesta)

**standard colours**

aluminium RAL 9006  
black RAL 9005

**code**

-AL\*  
-N\*

\* add to product code

**fixture features:**

- composite high resistance technopolymer fixing base
- corrosion resistant die-cast aluminium body
- polyester powder coating, with a pluri-processed against corrosion (passed the exposure of over 1500 hours in a saline mist environment)
- AISI 304 stainless steel tamper-proof hardware, opened only with a special key
- silicone rubber gaskets
- unbreakable anti UV polycarbonate lens (**zack**) screen (**zack/F42 - zack/MLW**)
- built-in electrical components 230V - 50Hz
- complete with pre-wired watertight H07RN-F cable
- Class II insulation (on request)

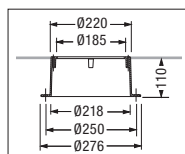
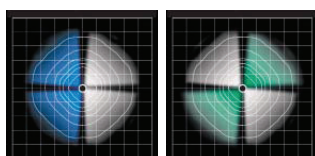
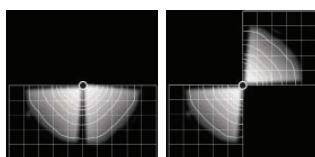
**accessori - accessories****D31/S0-B**

per modelli **zack** - for **zack** models

**D31/S0-A**

per modelli **zack/F42** - for **zack/F42** models

**settore oscurante - ampiezza 90°**

l'inserimento di uno o due settori oscuranti consente di ottenere effetti di luce differenziati, particolarmente interessanti. Senza l'uso dei settori la luce è emessa radialmente a 360°.

**N.B. inseribili in numero massimo di due pezzi per apparecchio.**

**darkening shield - 90°wide**

the use of one or two darkening shields provides the possibility of having different light effects.

Without using the shield the light is emitted radially at 360°.

**N.B. max 2 pieces per unit**

**D31/FB-B**

blu - blue

**D31/FB-V**

verde - green

**filtro di colore - ampiezza 90°**

coloured filters - 90°wide

per modelli **zack**

for **zack** models

**D31/FA-B**

blu - blue

**D31/FA-V**

verde - green

**filtro di colore - ampiezza 90°**

coloured filters - 90°wide

per modelli **zack/F42**

for **zack/F42** models

**D31/P****pozzetto da incasso**

l'accessorio D31/P, idoneo per i modelli D31/F18 - D31/MH35-D31/F42E, è previsto per essere incassato nel terreno e costituisce la base di fissaggio per l'apparecchio creando il vano per l'allacciamento elettrico e l'eventuale derivazione di linea.

**ground recessed pit**

the D31/P accessory, suitable for models D31/F18 - D31/MH35-D31/F42E, has been designed to be embedded in the ground, works as a support and fixing base creating also the necessary room for the electrical shunt connection to the feeding line.

**FE0551****chiave di apertura apparecchio**

opening key

**ACS/CR1**

connettore IP67 per cavo max Ø10,5 - 3x1,5 mm

fast IP67connector for cable max Ø10,5 - 3 x1,5 mm

per tutti i modelli

for all models

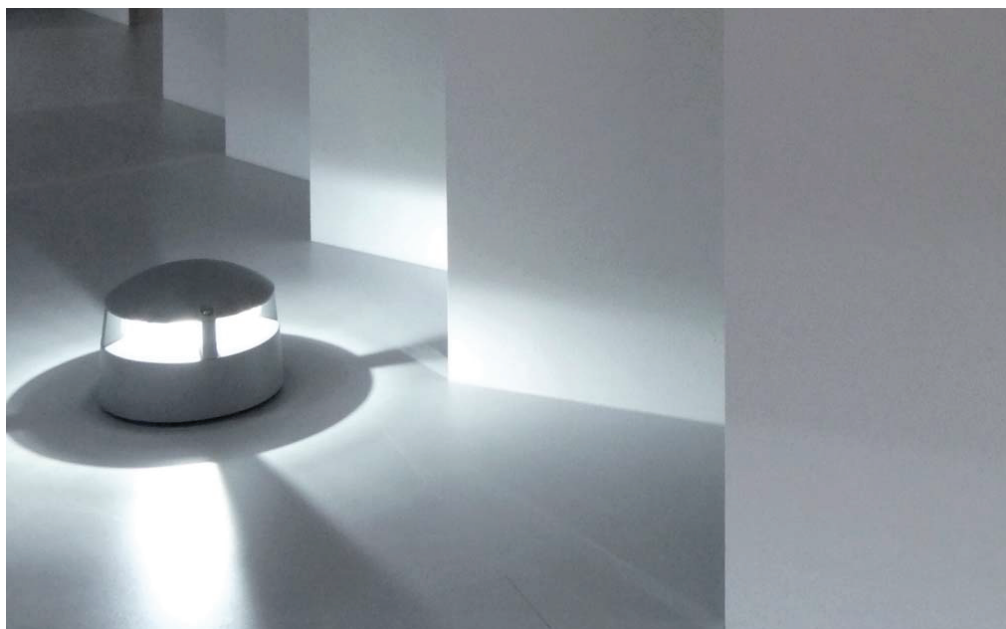



**zack**

IP67  $\nabla$  T  $\oplus$   $\otimes$   $\text{CE}$   $\text{E}$  - IK10

<b>D31/F18-AL</b>		fluorescente compatta compact fluorescent	18W	GX24d2	1200lm
<b>D31/MH35-AL</b>		alogenuri metallici metal halide	35W	G12	3300lm

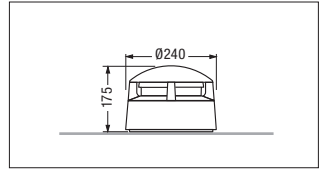

**D31/F18**

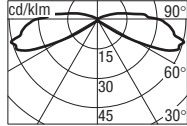

**D31/F18**

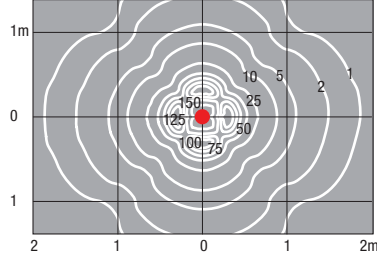

distribuzione  
isolux al suolo  
isolux distribution  
on ground

**D31/MH35**

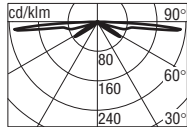

**D31/MH35**

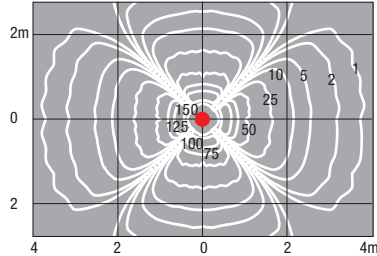

distribuzione  
isolux al suolo  
isolux distribution  
on ground



**zack LED**

IP67  $\nabla$  T  $\oplus$   $\otimes$   $\text{CE}$   $\text{E}$  - IK10

<b>D31/MLW*</b>		LED a luce bianca 5000K** con alimentatore elettronico 230/12V-50/60Hz LED white light 5000K** built-in transformer 220/240V-50/60Hz	25W		2600lm
**a richiesta 3000K - **3000K on request					

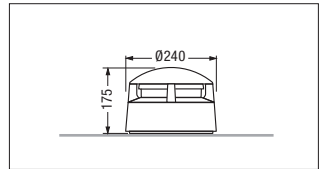

**new**

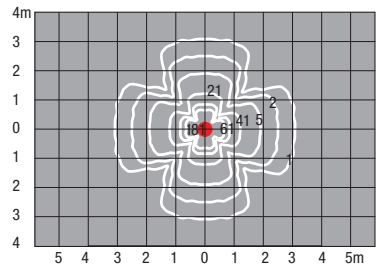
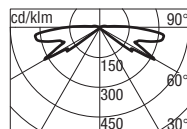

distribuzione isolux al suolo  
isolux distribution on ground

**zack/F42E**

IP67 - IK10

<b>D31/F42E-AL</b>	fluorescente compatta	26W	GX24q3	1800lm
	con alimentatore elettronico	32W	GX24q3	2400lm
	multipotenza 220/240V-50/60Hz	42W	GX24q4	3200lm
	compact fluorescent			
	electronic ballast			
	multipower ballast 220/240V-50/60Hz			

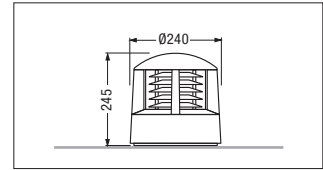
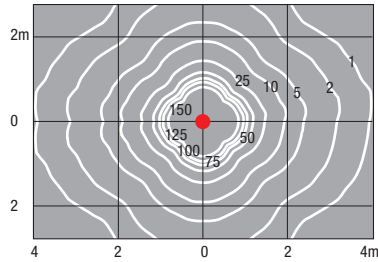
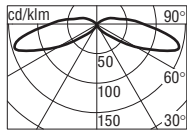
distribuzione isolux  
al suolo  
isolux distribution  
on ground**zack/E27**

IP67 - IK10

<b>D31/E27-AL</b>	fluorescente compatta	23W	E27	1500lm
	con alimentatore integrato*			
	compact fluorescent with integral ballast*			

\* tipo Master PL Philips - \* type Master PL Philips

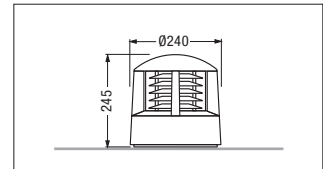
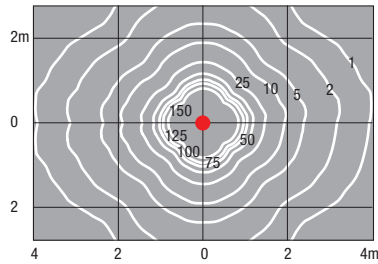
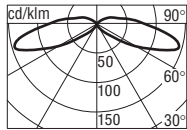
distribuzione isolux  
al suolo  
isolux distribution  
on ground



**zack/CM** IP67 - IK10

<b>D31/CMF18-AL</b>		fluorescente compatta compact fluorescent	18W	GX24d2	1200lm
<b>D31/CMMH35-AL</b>		alogenuri metallici metal halide	35W	G12	3300lm

### supporto a colonna

- supporto a colonna in acciaio inox AISI 304
- verniciatura a polveri
- colore alluminio RAL 9006
- viteria inox AISI 304

### column mounting

- stainless steel AISI 304 bollard stand
- powder painting
- aluminium RAL 9006 colour
- stainless steel hardware AISI 304

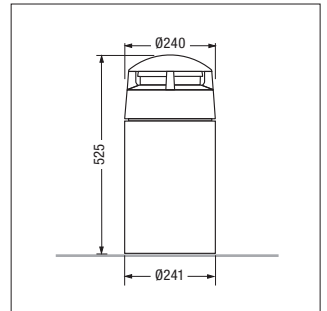

**zack/CM** IP67 - IK10

<b>D31/CMF42E-AL</b>		fluorescente compatta			
		con alimentatore elettronico	26W	GX24q3	1800lm
		multipotenza 220/240V-50/60Hz	32W	GX24q3	2400lm
		compact fluorescent	42W	GX24q4	3200lm

electronic operation  
multipower ballast 220/240V-50/60Hz

<b>D31/CME27-AL</b>		fluorescente compatta con alimentatore integrato*	23W	E27	1500lm
---------------------	--	--	-----	-----	--------

compact fluorescent with  
integral ballast\*

\* tipo Master PL Philips - \* type Master PL Philips

### supporto a colonna

- supporto a colonna in acciaio inox AISI 304
- verniciatura a polveri
- colore alluminio RAL 9006
- viteria inox AISI 304

### column mounting

- stainless steel AISI 304 bollard stand
- powder coat painting
- aluminium RAL 9006 colour
- AISI 304 stainless steel hardware

